

www.niessing.de



Concepts for reducing
noise and smoke



Letting off more than just steam

Industrial engines and diesel generators are often used to provide an uninterrupted electricity supply for power stations, hospitals and data centres. In some instances they are used as emergency generators, but in the shipbuilding industry they are a true driving force. These engines have a power output of up to 20 MW and generate an immense amount of background noise while they are in operation.

Silencer systems for industrial engines

Very stringent sound insulation regulations apply when industrial engines are located near residential areas. It is mainly the low-frequency noise range that reaches the ears of local residents, and this must be avoided completely on a long-term basis. This is the kind of challenge that plant operators must deal with at an early stage, ideally with the help of a silencer system expert such as Nießing Anlagenbau GmbH.



During the planning stage, Nießing uses individual layouts for the exhaust gas and silencer systems. Experience has shown that the situation in every plant is very different.



Generate electricity with a clear conscience

Improvements to the efficiency of turbines and engines do not automatically lead to quieter generators. The layout of the buildings in which the turbines or diesel generators are located also presents individual requirements for the exhaust air systems and the level of soundproofing that is required. In most instances, Nießing encounters initial situations that are simply a matter of layout. This is the kind of challenge that Nießing faces on a regular basis.

Skilful reduction of noise emissions is the key

The stringent requirements that apply to exhaust gas emissions also apply to noise emissions. Nießing has the best facilities for permanently eradicating disruptive noise while complying fully with all relevant regulations. This company has a long history and, over the decades, has come to specialise in supplying all the required components, starting with its own energy generator (boiler, motor etc.), and using them to create a turnkey installation.



Soundproofing regulations are particularly stringent in residential areas. Nießing is an experienced expert in all logistical challenges



Nießing silencer systems are also used in turbines that are subjected to high temperatures





Biogas plants with environmentally friendly dampers

Biogas plants are an integral part of modern agriculture and are an increasingly visible presence in rural areas. There is no question that the level of productivity of these plants is high, as they often operate around the clock. Considerable noise emissions are produced when gas or diesel generators with substantial KW power outputs are in non-stop operation. Biogas plants are increasingly being located near residential areas and built-up areas, which means that a concerted effort must be made to soundproof these generators using efficient silencer systems.

A-weighted third octave sound level of an engine at the Tonal components at engine ignition frequency (75–80 Hz)

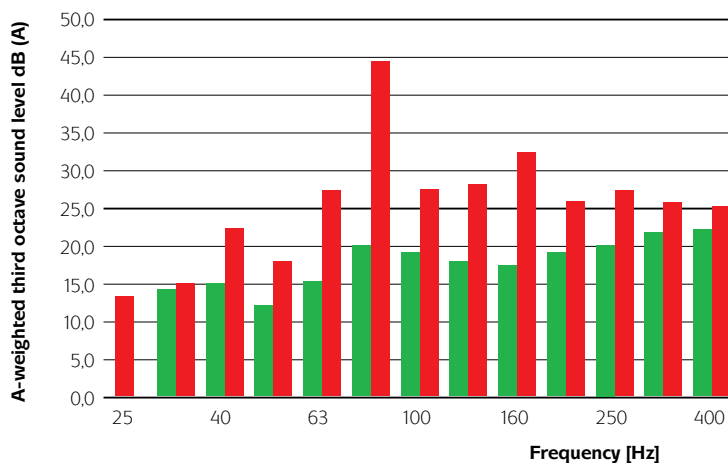

Comparison of the third octave sound level when using a standard absorption silencer and a Nießing silencer

Silencing low frequencies

The noise of engines carries for long distances. In the case of biogas plants, the noise can approach unbearable levels within a radius of 50 metres or more. Help is at hand: Nießing can supply the plant components required to reduce noise emissions, particularly the lower frequencies.



Typical exhaust gas silencer installation for a biogas plant. The main priority here is the elimination of low frequencies (engine ignition frequency)



Keep a lid on low frequencies

emissions measuring point (within approx. 40 m)

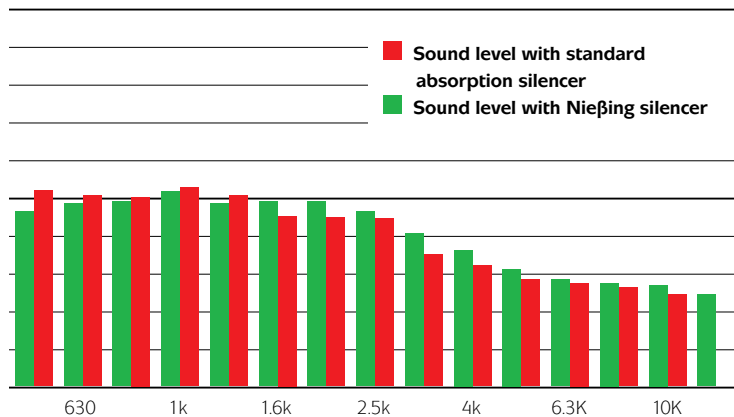

Production workshops and utility companies work with exhaust air plants that have been planned and installed by Nießing. The expertise that Nießing provides is of particular importance for the exhaust air pipe and silencer systems used in biogas plants. Nießing measures the noise level using established sound propagation programmes and assesses the status in accordance with technical noise regulations. Nießing uses exhaust pipe and silencer systems to tackle lower frequencies.

Volume resonator for broadband damping



Nießing has developed these special silencers in conjunction with the Fraunhofer Institute for Building Physics in Stuttgart. The exhaust gas flue is completely encased in a chamber. The high pressure losses and operating costs associated with conventional absorption silencers are now a thing of the past. Designed for easy retrofitting, this type of silencer is suitable for use in many other facilities besides biogas plants.



Housing for a biogas generator in a container with adequate silencer system





A change of scene in the automotive industry

The automotive industry is increasingly turning to environmentally friendly and efficient silencer systems for its production processes. In 2008, a decision was made by Daimler AG to retrofit two exhaust air ducts at its Düsseldorf production site, replacing the conventional mineral wool panels that had been used previously.

Not just a strain on the ears

Analysis carried out before the retrofit showed that up to 60% of the 24 m² surface area of the exhaust air ducts was fitted with conventional mineral wool panels. The remaining area for the exhaust air was so small that high gap velocities were causing high pressure losses and, as a result, high energy consumption. The efficiency of the conventional silencers was also heavily restricted by paint residues. There is no doubt that replacing the ineffective silencers with Nießing plate absorbers as angular stack silencers was an ideal alternative for the exhaust air ducts. This was an interesting challenge, as each duct emits approximately 1.3 million m³ of exhaust gas into the atmosphere.



Exterior views of both exhaust air chimneys to be retrofitted

Detailed view of an old damper panel: a build-up of paint and solvent residue led to almost complete closure of the perforated plate cover, causing the silencer to operate inefficiently.



Positioning the plate absorber sections



Retrofit proves it worth



Installation of the 17.5 metre sections of plate absorber in the duct

In order to attain the required silencer depth of 17.5 metres – corresponding to the depth of the duct – Nießing bolted together individual 2.5 metre segments of plate absorber. A sturdy new piece of steelwork was installed in the upper opening of the duct to bear the weight of the silencer module. Sufficient space was left to ensure that the module can always expand in accordance with the ambient temperature.

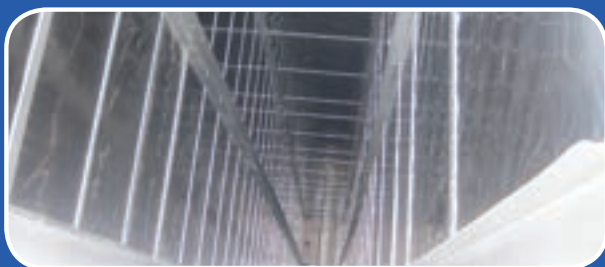

View from above into the 50 metre deep duct with installed sections of Nießing plate absorber

Improved energy footprint with new momentum

Nießing plate absorbers have provided Daimler with their money's worth. By changing the silencers in both exhaust air ducts, the company has achieved an energy saving of approximately 7,600 MWh/year. According to figures from Daimler, this equates to a cost saving of 610,000 EURO per year. At the same time, CO₂ emissions have been reduced by 3,000 tonnes per year, which approximately equates to the emissions created by 1,000 four-person households.

Energy saving for chimney 331 in megawatts/year

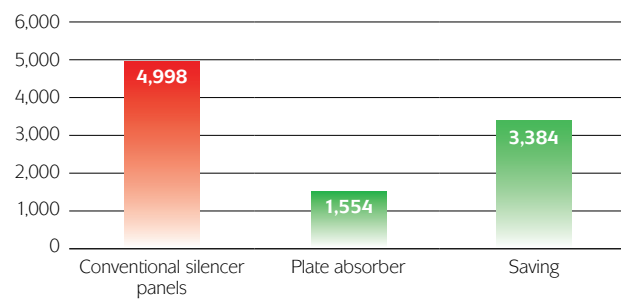

Energy saving for chimney 335 in megawatts/year

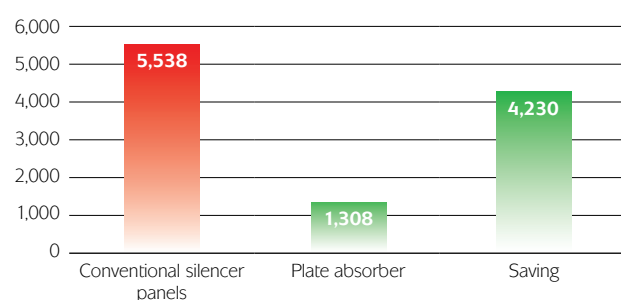



Peace brings power

Fit for more than just the high seas: people who cruise the world's oceans at a speed of 25 knots and more are well used to comfort and luxury. Luxury vessels are impressive not only due to their size, but also because of the high level of modern technology on board.

High-performance silencers from Nießing provide the finishing touch to the level of comfort on board a luxury vessel, and really help to provide that feeling of luxury. The precise balance between the vessels' engine and the high-performance silencer creates ideal conditions for maximum noise reduction coupled with flexible performance. Acoustic approval testing for the Nießing silencer is carried out on a test bench at the factory.



Full steam ahead

A high level of technical performance is essential for a feeling of real nautical exhilaration. There is no room for any extraneous noise, in particular low-frequency engine noise.



Individual space requirements in the hull of the vessel require individual build layouts for the silencer systems. Nießing can adapt its solutions to fit any situation





Acoustic silencers for the tightest of spaces

Machines and equipment on board luxury vessels are often housed in the smallest of spaces as the spacious areas of the boat are reserved for the luxurious living and leisure quarters. High-performance silencers from Nießing fit the space available - especially when it comes to restricted installation conditions. Individual silencer measurements are available to suit every requirement.

Get to your destination with no pressure loss

Nießing silencers generate minimal back-pressure while the efficiency of the engines remains almost constantly stable. The graph below clearly shows that there is a negligible loss of pressure in Nießing silencer systems. The values calculated by Nießing were measured and confirmed by the TÜV (Technical Inspection Association) for the purposes of certification.



Maximum silencing requires individual solutions, especially in restricted installation conditions

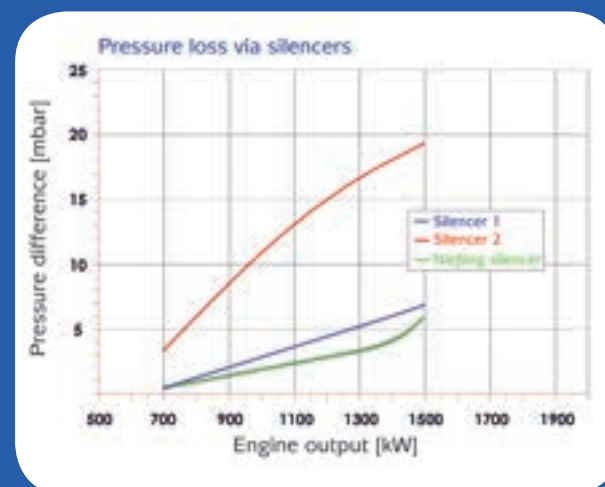



Simple exhaust gas solution

Engine test benches used to test combustion engines outside of their normal operating environment require exhaust air systems or extraction units that function economically. Nießing has used a centralised exhaust air system to create a linked network of all 29 Renault engine test benches. The noise emissions from the engines

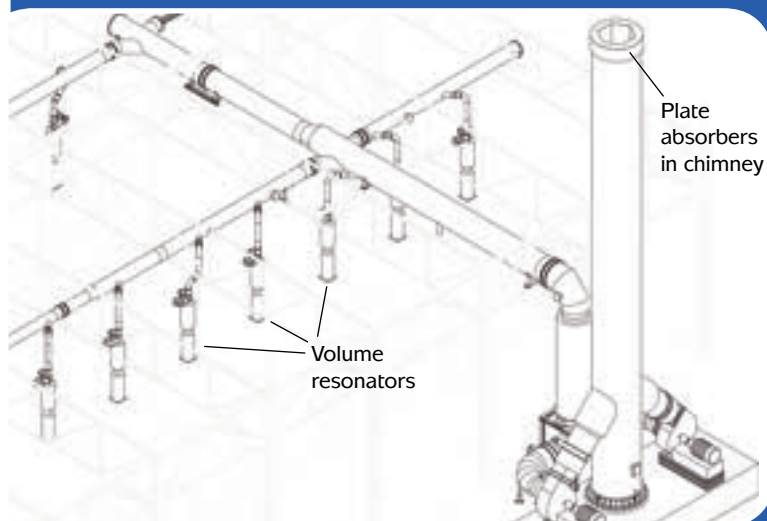

being tested are silenced using the broadband damping effect of Nießing volume resonators. The noise emissions from the fans are silenced by plate absorbers installed in the chimney.



Nießing exhaust air system for Renault engine test benches





From pure drive to pure performance

Nießing has long been involved with environmental technologies in order to develop its own catalytic converter silencer system that would be of particular use in biogas plants. This concept has been officially sponsored by the Federal Ministry of Economics and Technology. Nießing has also constructed its own test bench for its new product, ensuring a high level of quality assurance.

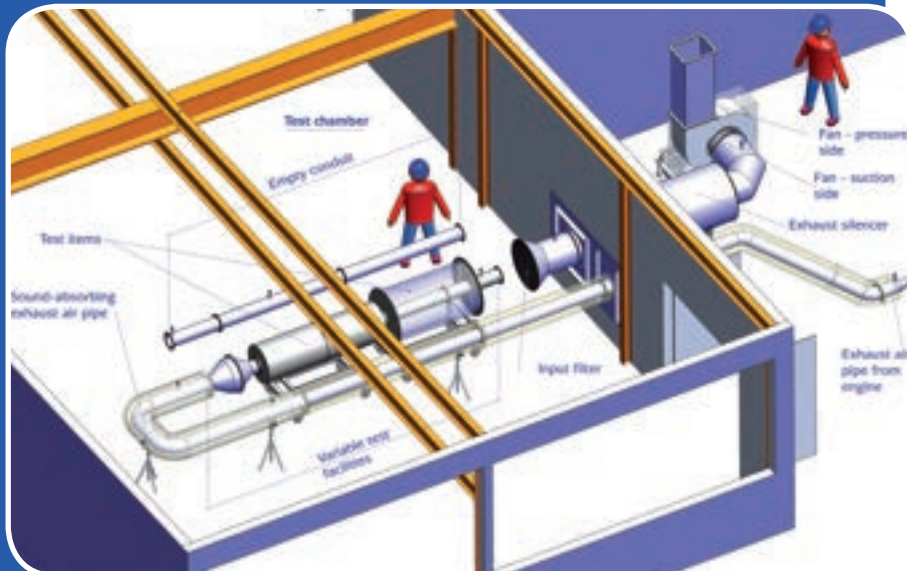

With its own test bench technology, nothing else can stand in the way of the development of catalytic converter elements for biogas plants.



Measuring sound levels from the Nießing test bench



Five good reasons to choose Nießing products:

- Nießing exhaust air systems cause negligible pressure loss.
- Nießing exhaust air systems are particularly space-saving thanks to their integrated and compact construction.
- Nießing silencer systems are effective at low frequencies and ensure extensive emissions protection.
- Nießing silencer systems are not sensitive to contamination and have negligible maintenance costs.
- Nießing exhaust air and silencer systems are pre-assembled in the factory and can be installed in a very short time.



Volume resonator with cleaning facility

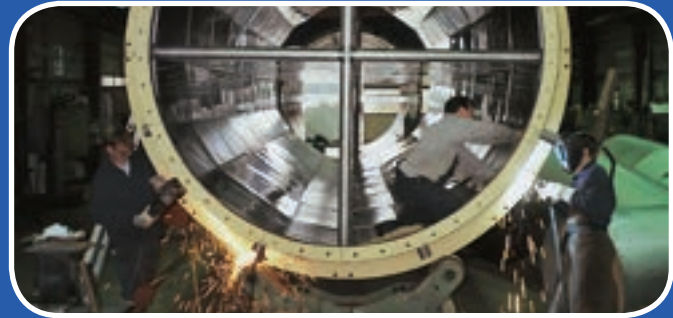

Manufacturing a Nießing plate absorber silencer system



Transport of a steel chimney to installation location (international shipping and assembly are a daily occurrence for Nießing)



Nießing Anlagenbau GmbH

Marbecker Strasse 74
46325 Borken-Marbeck
Germany

Phone +49 (0) 2861 – 945 – 0
Fax +49 (0) 2861 – 945 – 139

www.niessing.de



Nießing – worldwide!